

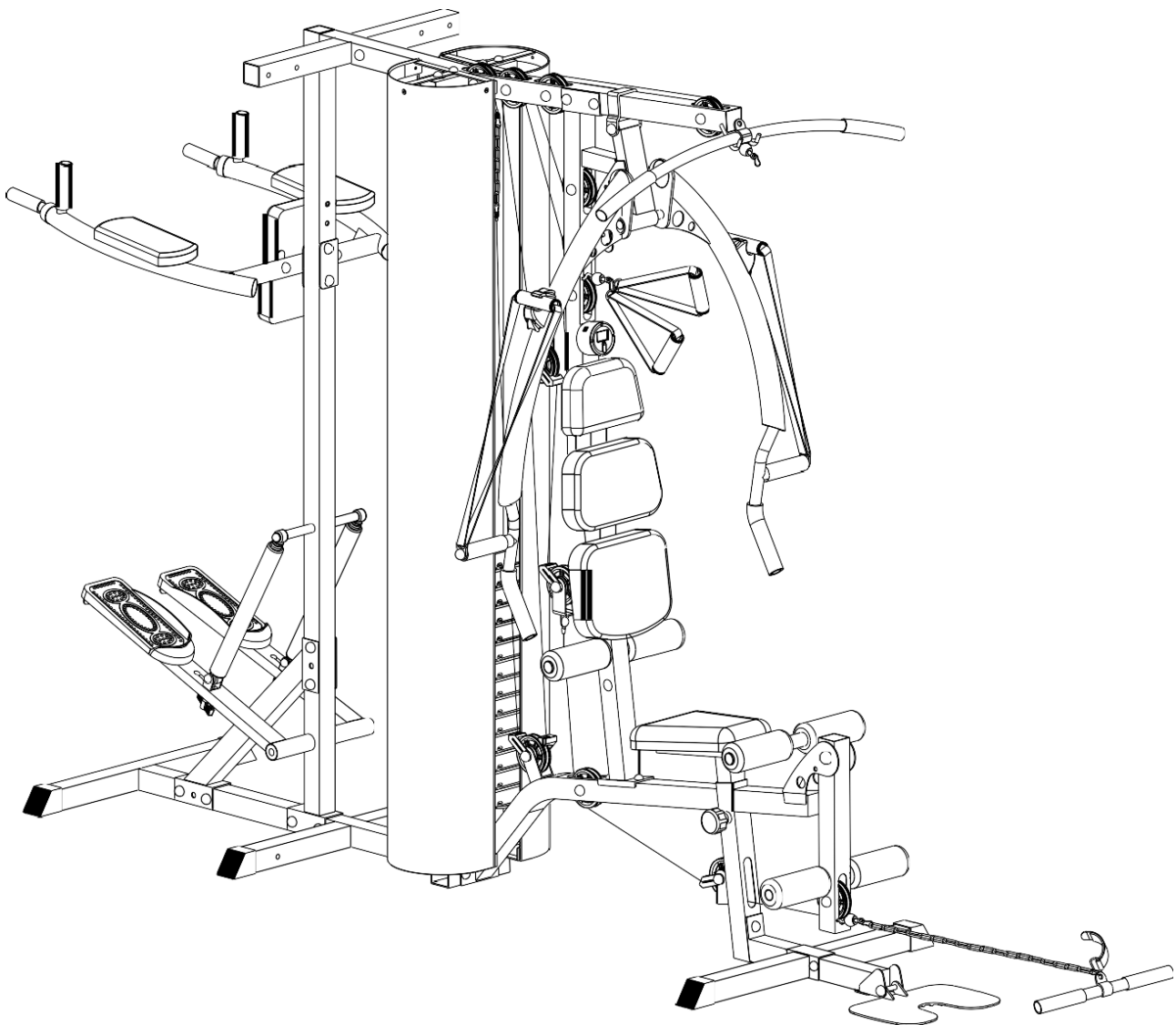

Manual de utilizare

Aparat multifunctional IN18397

Phanton



Lista Piese:







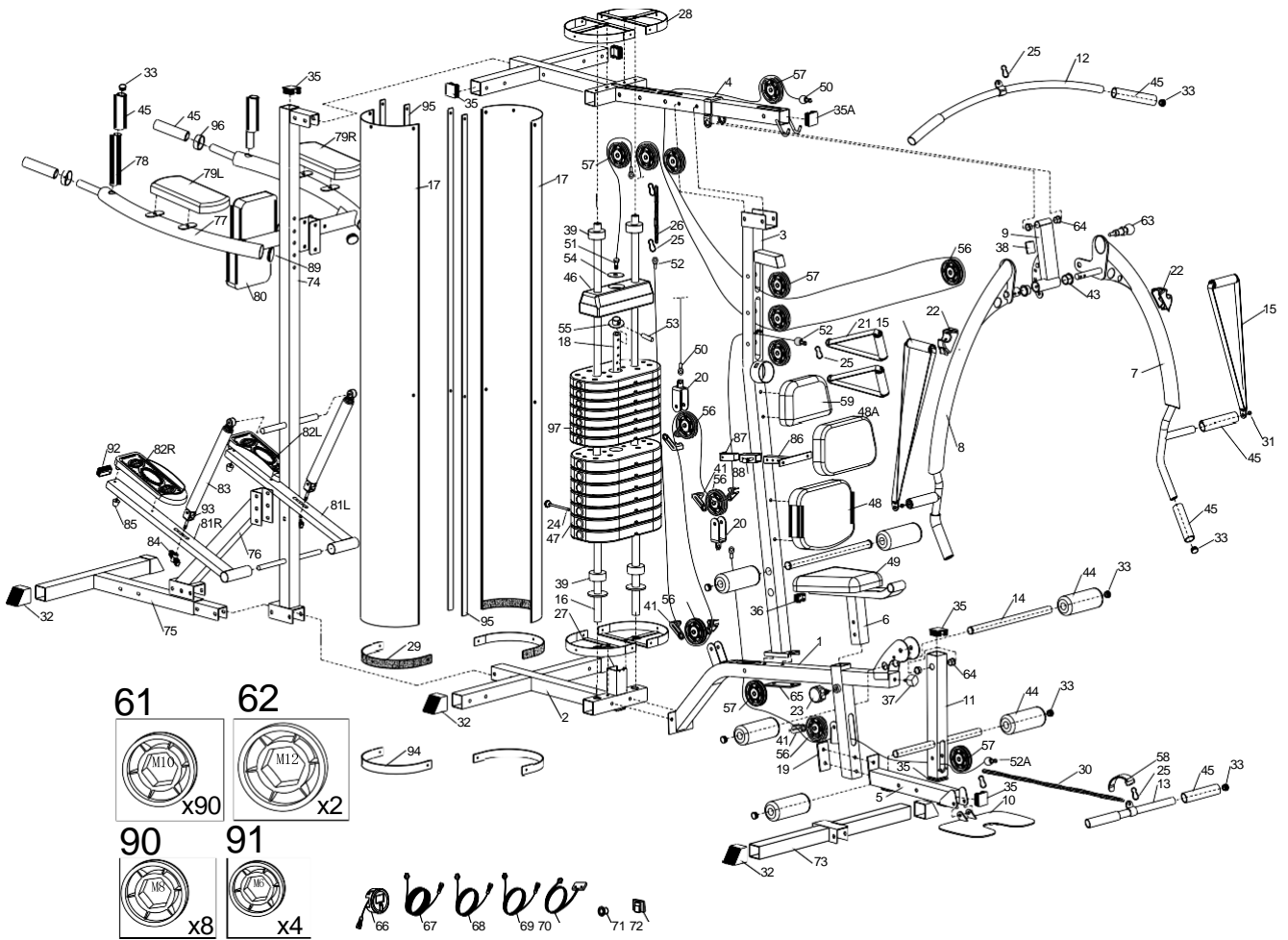



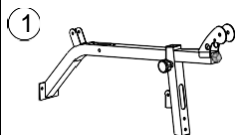
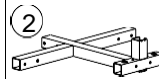
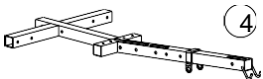







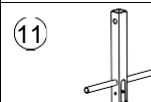
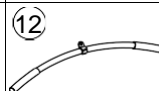
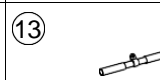
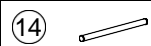

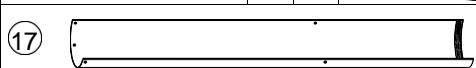
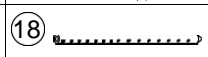
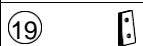
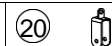
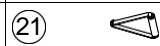

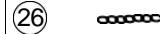

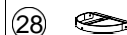
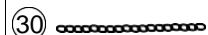
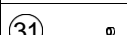
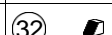
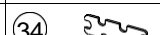
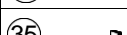
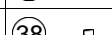
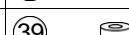
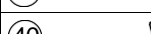

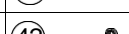
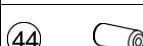



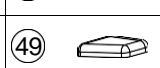



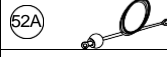
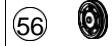
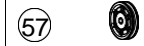
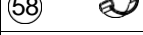
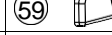
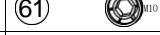

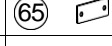
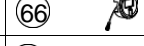
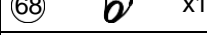



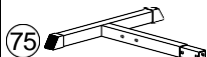



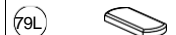

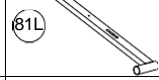
Part No.	Descriptie	Q'ty	Part No.	Descriptie	Q'ty
1	Cadru principal	1	64	Saiba D29*D21.5*D10.2	4
2	Cadru mijloc podea	1	65	Placa fixanta 50*120*3T	1
3	Suport vertical frontal	1	66	Computer BC-80258	1
4	Cadru superior	1	67	Cablu computer superior 720L	1
5	Cadru frontal podea	1	68	Cablu computer mijloc 550L	1
6	Suport scaun	1	69	Cablu computer inferior 400L	1
7	Bara fluture stanga	1	70	Cablu senzor 110L	1
8	Bara fluture dreapta	1	71	Mufa D4*D12*13	2
9	Suport bare fluture	1	72	Prindere cablu computer	3
10	Suport picioare	1	73	Stabilizator frontal	1
11	Tub extensie picioare	1	74	Suport spate vertical	1
12	Bara tragere superioara	1	75	Cadru podea spate	1
13	Bara tragere inferioara	1	76	Suport spate inclinat	1
14	Ax rotator spuma	2	77	Suport pentru suporti maini	1
15	Curea (material) 40*650	2	78	Ghidon	2
16	Bara ghidare greutate cromata	2	79L	Suport mana stanga	1
17	Protectie greutate	2	79R	Suport mana dreapta	1
18	Tub selectie greutate	1	80	Spatar	1
19	Placa fixanta	1	81L	Suport pedala stanga	1
20	Loc scripete singular	2	81R	Suport pedala dreapta	1
21	Curea (material) 240*130	2	82L	Pedala stanga	1
22	Aparatore 100.3*48*45	2	82R	Pedala dreapta	1
23	Surub D56*M16*24*D8	1	83	Cilindru hidraulic	2
24	Cui bila	1	84	Surub T	1
25	Carlig D8*80	6	85	Amortizor D33*D44*41.5	2
26	Lant D4.8*18*34*248	1	86	Suport coidal	1
27	Suport protectie greutate inferior	2	87	Capac gol 30*30*65L	1
28	Suport protectie greutate superior	2	88	Surub D30*M16*1.5*29*D8	1
29	Prinzator incheietura 496*30	2	89	Capac rotund D50*15	2
30	Lant D4.8*18*34*613	1	90	Capac surub D28*14 (M8)	8
31	Saiba D10*D12*5T	2	91	Capac surub D28*17 (M6)	4
32	Capac picior 50*50*76.5*4.5t	6	92	Capac patrat 50*50*18.5	2
33	Capac rotund D17*17.5	16	93	Balama fixanta cilindru hidraulic	2
34	Cheie	2	94	Placa curbata	2
35	Capac patrat 50*50*18.5	5	95	Tub fixant	4
35A	Capac patrat 50*50*20L	1	96	Capac gol D50.8*D26*D20L	2
36	Capac patrat 20*50*14	1	97	Placa greutate de mijloc	7

37	Amortizor 35*35*25	1	100	Surub M10*1.5*75L	14
38	Amortizor patrat 42*42*5T	1	101	Saiba plata D20*D11*2T	76
39	Amortizor rotund D60*D26*26T	2	102	Piulita nylon M10*1.5*10T	37
40	Imbus	1	103	Bolt M10*1.5*65L	18
41	Bara ghidare tragere	7	104	Bolt M10*1.5*70L	4
42	Inel plastic a barii tragere	7	105	Surub M8*25L	2
43	Saiba D38*D35.2*32	2	106	Saiba plata D24*D13.5*2.5T	2
44	Spuma D23*D80*175L	6	107	Piulita nylon M12*1.75*12T	1
45	Spuma D23*D35*127L	12	108	Surub M10*1.5*55L	1
46	Placa superioara greutati	1	109	Surub M10*1.5*40L	2
47	Placa inferioara greutati	7	110	Surub M10*1.5*20L	2
48	Spatar inferior	1	111	Surub M12*1.75*85L	1
48A	Spatar mijloc	1	112	Surub M10*1.5*60L	3
49	Scaun	1	113	Surub M10*1.5*95L	1
50	Cablu (III) 3270L	1	114	Surub M10*1.5*25L	10
51	Cablu (IV) 1430L	1	115	Surub M5*0.8*20L	6
52	Cablu (II) 3040L	1	116	Saiba plata D15*D5.2*1.0T	6
52A	Cablu (I) 1535L	1	117	Bolt M6*1*20L	4
53	Cui selector superior dreapta	1	118	Saiba plata D14*D6.5*0.8T	12
54	Saiba plata D47.5*D13*3T	1	119	Piulita nylon M6*1*6T	4
55	Loc selector superior greutati	1	120	Surub M8*1.25*15L	2
56	Saiba Inaltatoare D90*D10*28.5	5	121	Saiba plata D28*D8.5*3T	4
57	Saiba plata D90*D10*24	9	122	Saiba plata D38*D8.5*3T	2
58	Prinzator glezna 295*95	1	123	Saiba plata D19*D8.5*1.6T	8+4
59	Perna cap	1	124	Surub M6*1*35L	2
60	Saiba D18*D10*14.5	18	125	Surub M8*1.25*20L	6
61	Capac surub D28*17*(M10)	90	126	Saiba arcoidala D15.4*D8.2*2T	4
62	Capac surub D30*17*(M12)	2	127	Surub M6*1*40L	2
63	Cui arc	1	128	Surub M8*65L	4

Desen detaliat:



Lista de componente

	x1		x1		x1
			x1		
	x1		x1		x1
	x1		x1		x1
	x1		x1		x1
	x2		x2		x2
	x2		x1		
	x1		x2		x2
	x1		x6		x1
	x2		x2		x1
	x2		x2		x2
	x2		x1		x4
	x1		x7		x7
	x6		x1		x7
	x1		x1		x1
	x1		x1		x1
	x1		x5		x9
	x1		x1		x90
	x2		x1		x1
	x1				x7
	x1		x1		
	x1				x1
	x1		x2		x1
	x1		x1		x1
	x1		x1		x2
	x2		x1		x8
	x4		x2		

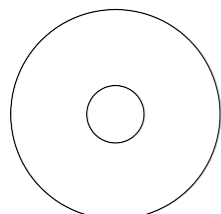
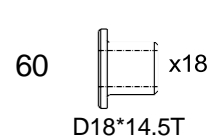
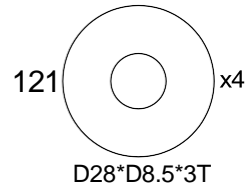
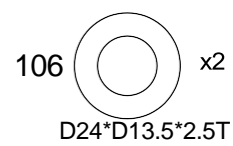
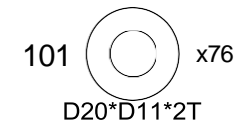
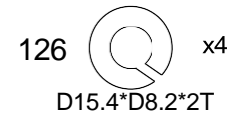
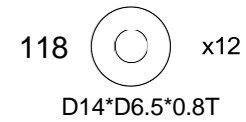
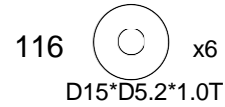
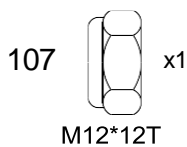
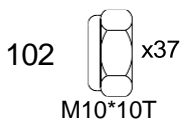
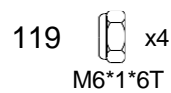
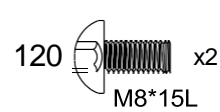
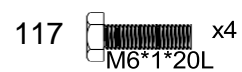
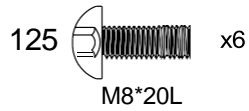
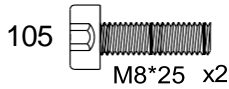
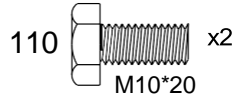
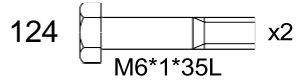
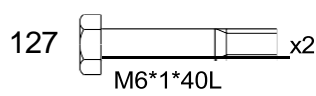
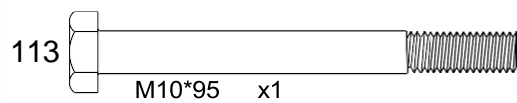
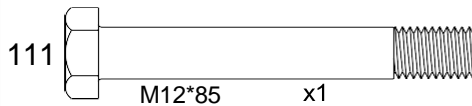
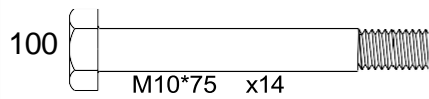
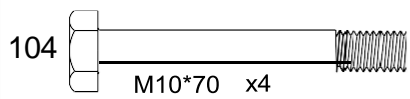
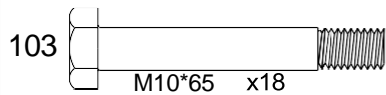
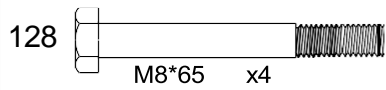
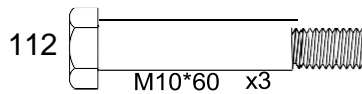
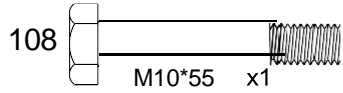
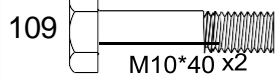
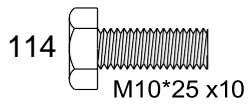

54 D47.5xD13 x1

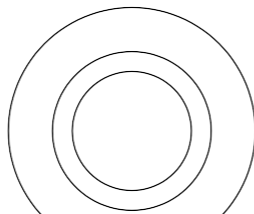

55 D56xD27 x1

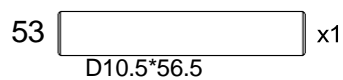

53 D10.5*56.5 x1

ASAMBLAREA

Pasul 1

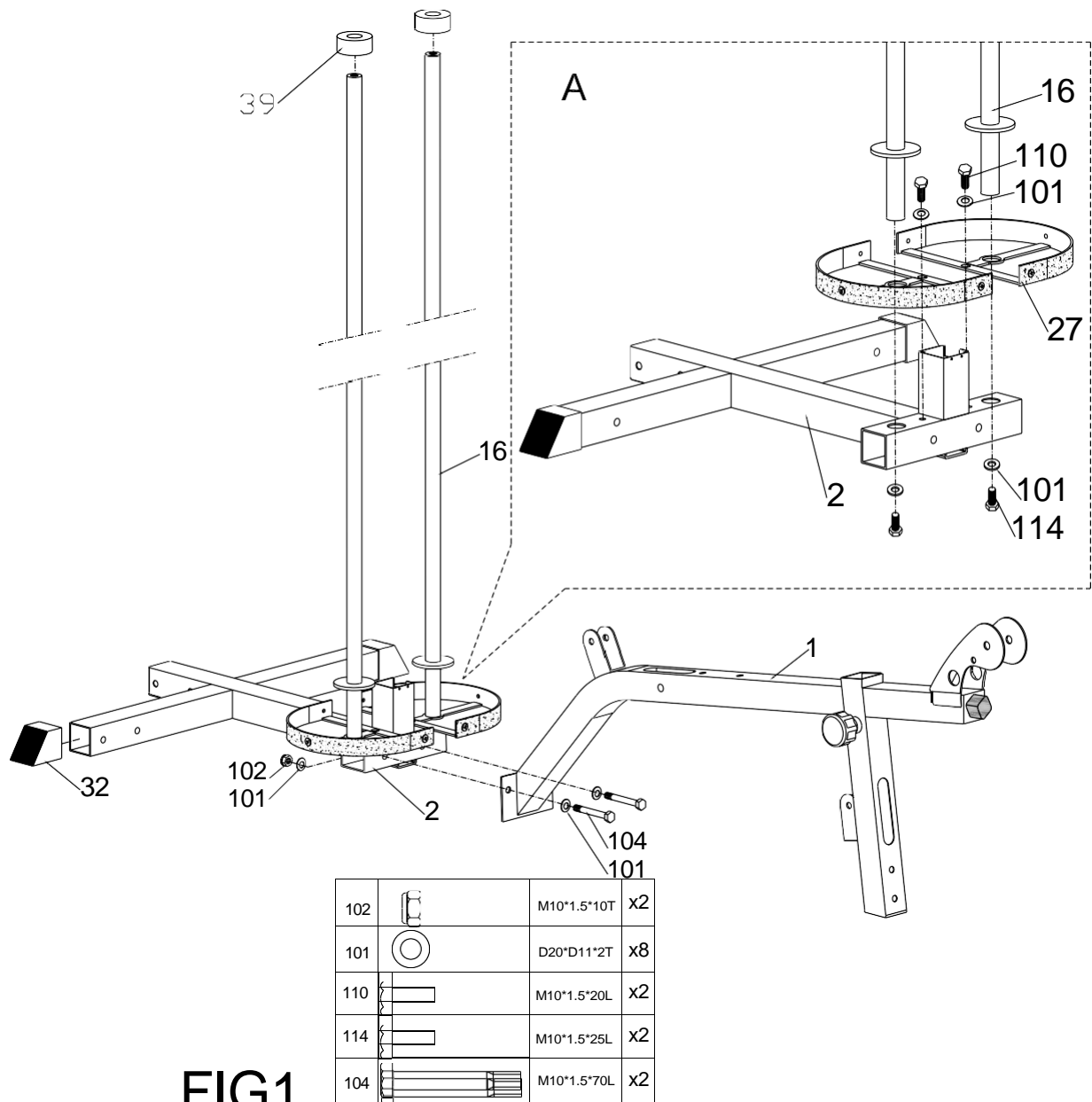

FIG1

- 1) Asamblati cadrul principal (1) la cadrul de mijloc podea (2) langa saiba plata (101), piulita de nylon (102) si SURUBULUI(104).
- 2) Asamblati aparatoarea de greutate inferioara (27) shi barile de ghidare cromate (16) la cadrul de mijloc podea (2) langa saiba plata (101), surub (110) si surubul (114) ca in fig. A.
- 3) Asamblati suportul picioare (32) la cadrul de mijloc podea (2).

Pasul 2

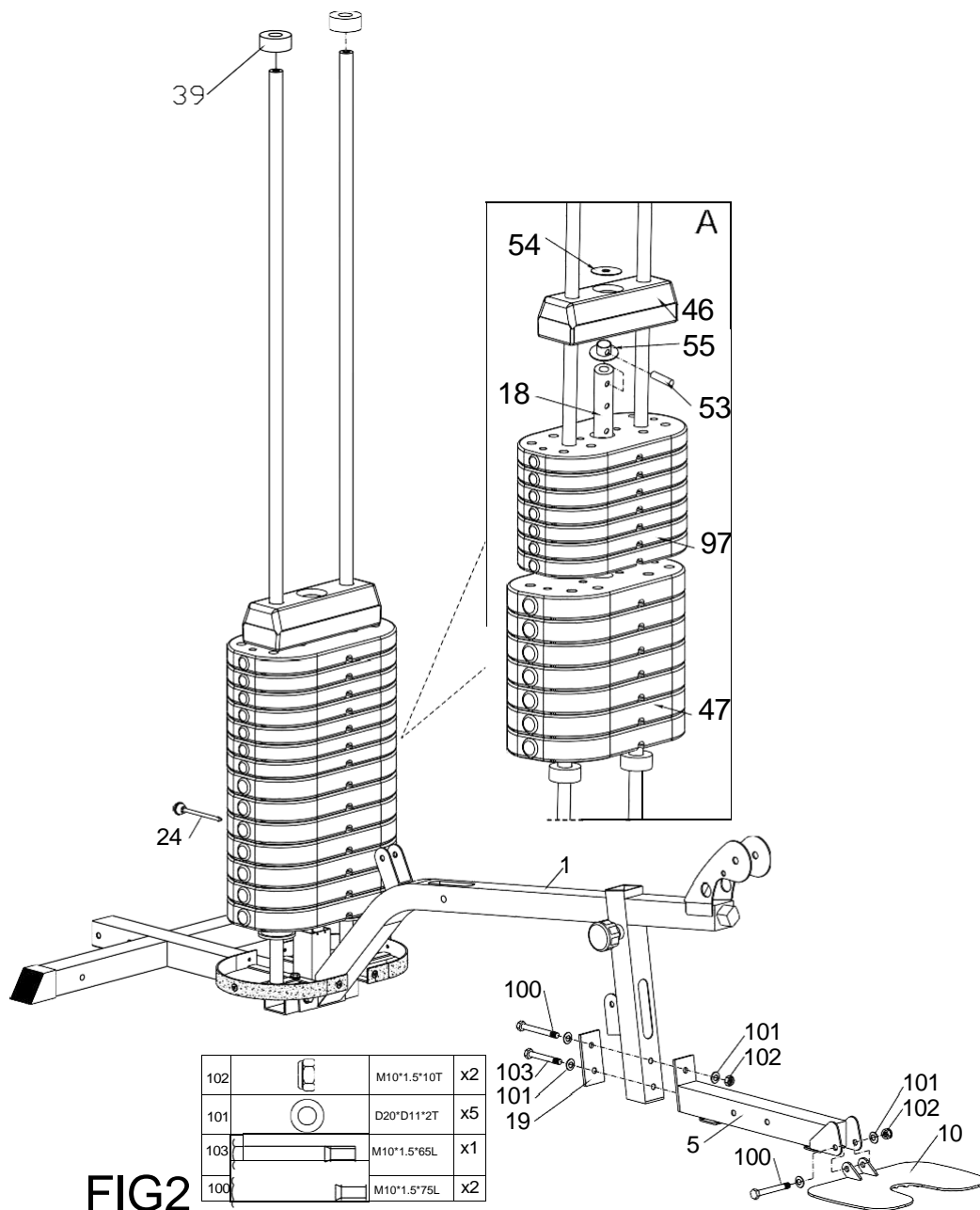

FIG 2

- 1) Montati placa inferioara greutati (47), plac de mijloc greutati (97) si placa superioara greutati (46) la barele cromate de ghidare (16) ca in fig. A. Puneti saiba plata (54) pe gaura placii superioare de greutati (46).
- 2) Montati suportul pentru selectorul superior de greutati (55) la tubul selectorului de greutati (18) si fixate suportul langa cuiul selectorului superior de greutati (53). Puneti tubul selectorului de greutati (18) in gaurile greutatilor.
- 3) Montati cadrul frontal podea (5) la cadrul principal (1) langa placa fixanta (19), saiba plata (101), surubul (103) si surubul (100) si piulita nylon (102).
- 4) Montati suportul picioare (10) la cadrul frontal podea (5) cu surub (100), saiba plata (101) si piulita nylon (102).
- 5) Utilizatorii pot selecta antitatea de greutati folosind cuiul de greutati (24).

Pasul 3

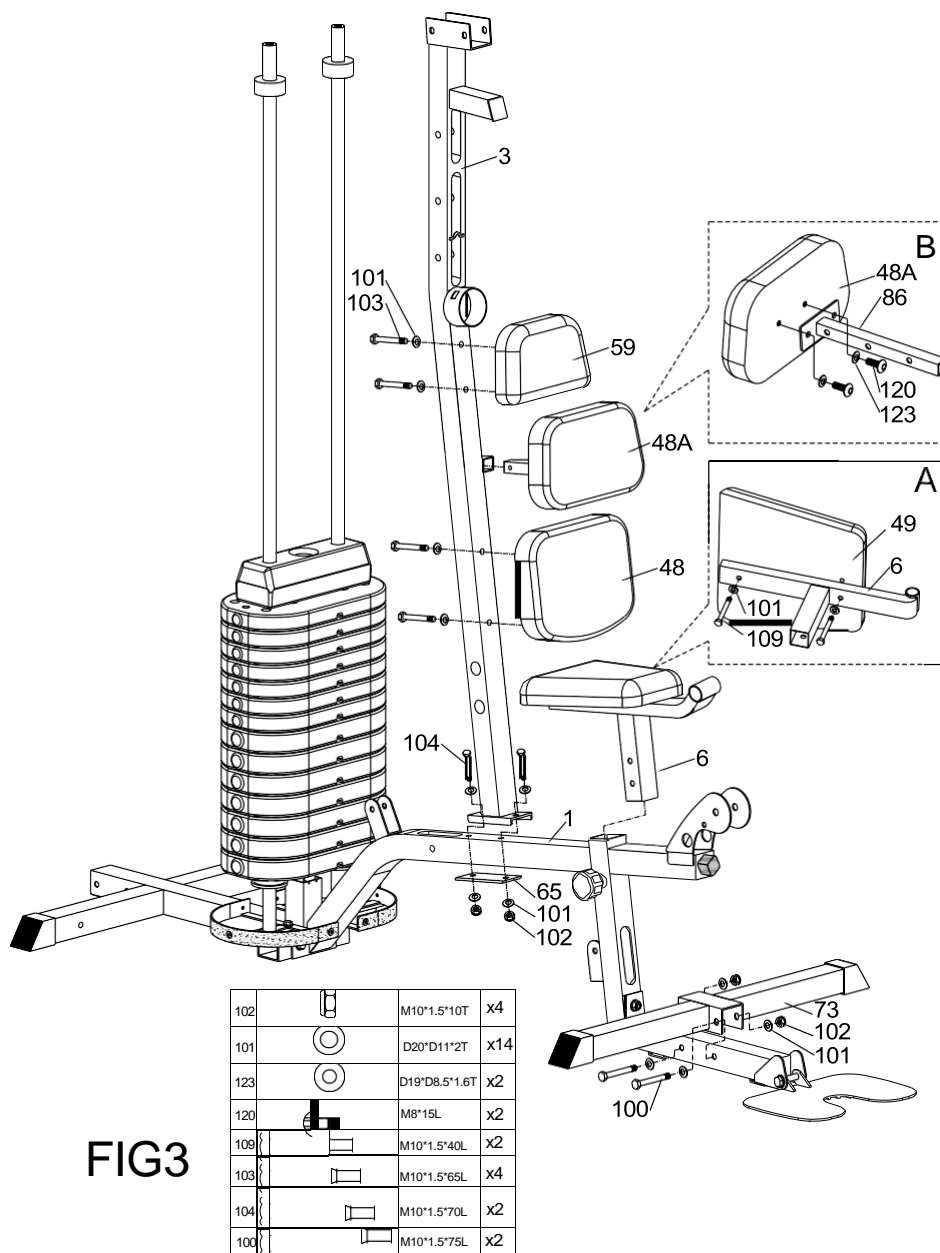

FIG3

- 1) Montati suportul frontal vertical (3) la cadrul principal (1) langa placa fixanta (65), cu saiba plata (101), surub (104) si piulita nylon (102).
- 2) Montati scaunul (49) la suportul de scaun (6) cu saiba plata (101) si surub (109) ca in fig. A. Asamblati suportul de scaun (6) la cadrul principal (1).
- 3) Montati spatarul de mijloc (48A) la suportul coidal (86) cu surub (120) si saiba plata (123) ca in fig. B.
- 4) Montati perna cap (59), spatarul de mijloc (48A) si spatarul inferior (48) la suportul vertical frontal (3) cu saiba plata (101) si surub (103).
- 5) Montati stabilizatorul frontal (73) la cadrul frontal podea (5) cu surub (100), saiba plata (101) si piulita nylon (102).

Pasul 4

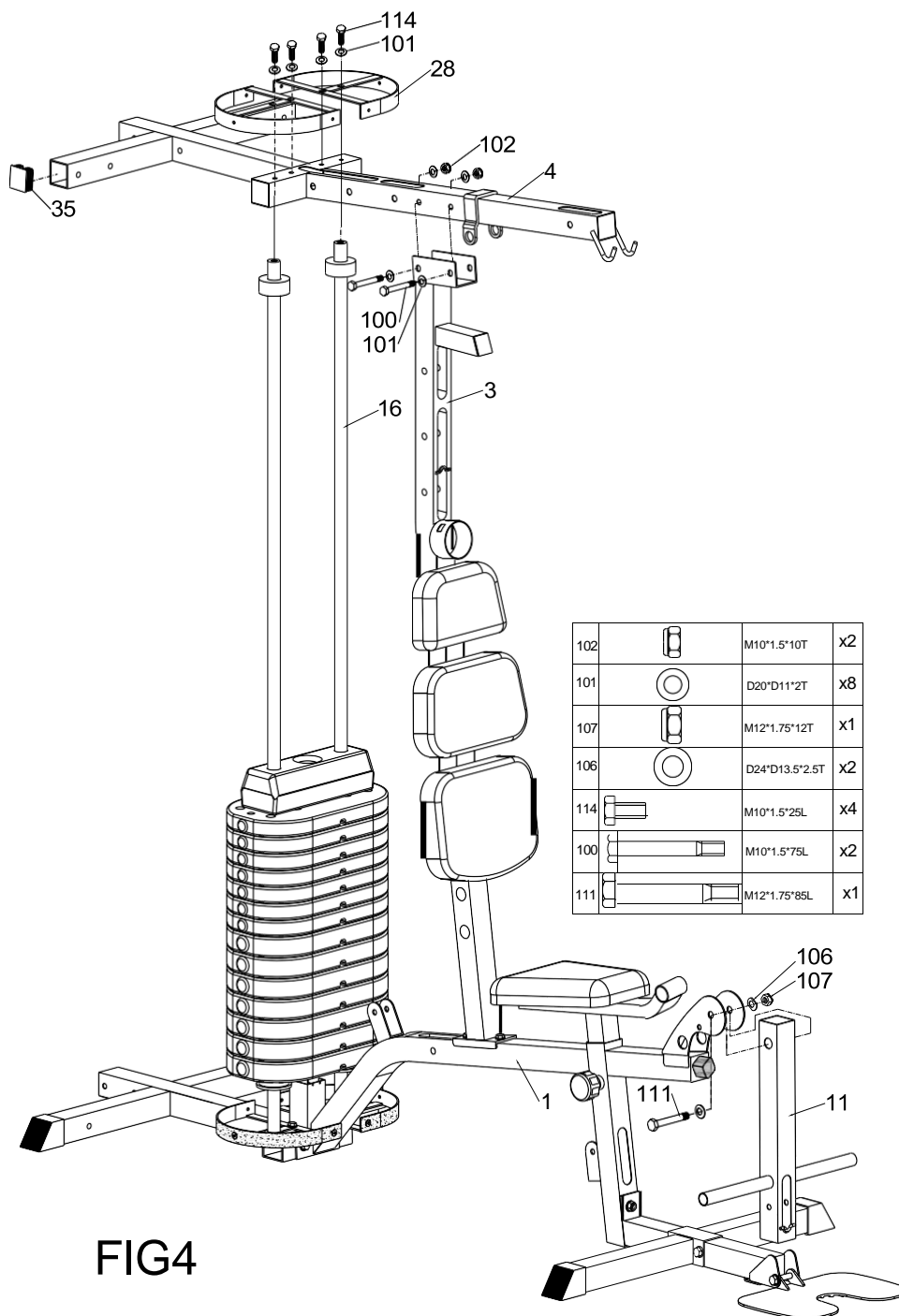

FIG4

- 1) Montati cadrul superior (4) la bara ghidare greutati cromata (16) si suportul frontal vertical (3). Montati capacul patrat (35) la cadrul superior (4).
- 2) Montati suportul superior de protectie greutati (28) la cadrul superior.
- 3) Montati suportul superior protectie greutati (28), la cadrul superior (4) si bara ghidare greutati cromata (16) cu saiba plata (101) si surub (114).
- 4) Fixati cadrul superior (4) la suportul vertical frontal (3) cu surub (100), saiba plata (101) si piulita nylon (102).
- 5) Montati tubul extensie picioare (11) la cadrul principal (1) cu saiba plata (106), piulita nylon (107) si surub (111).

Pasul 5

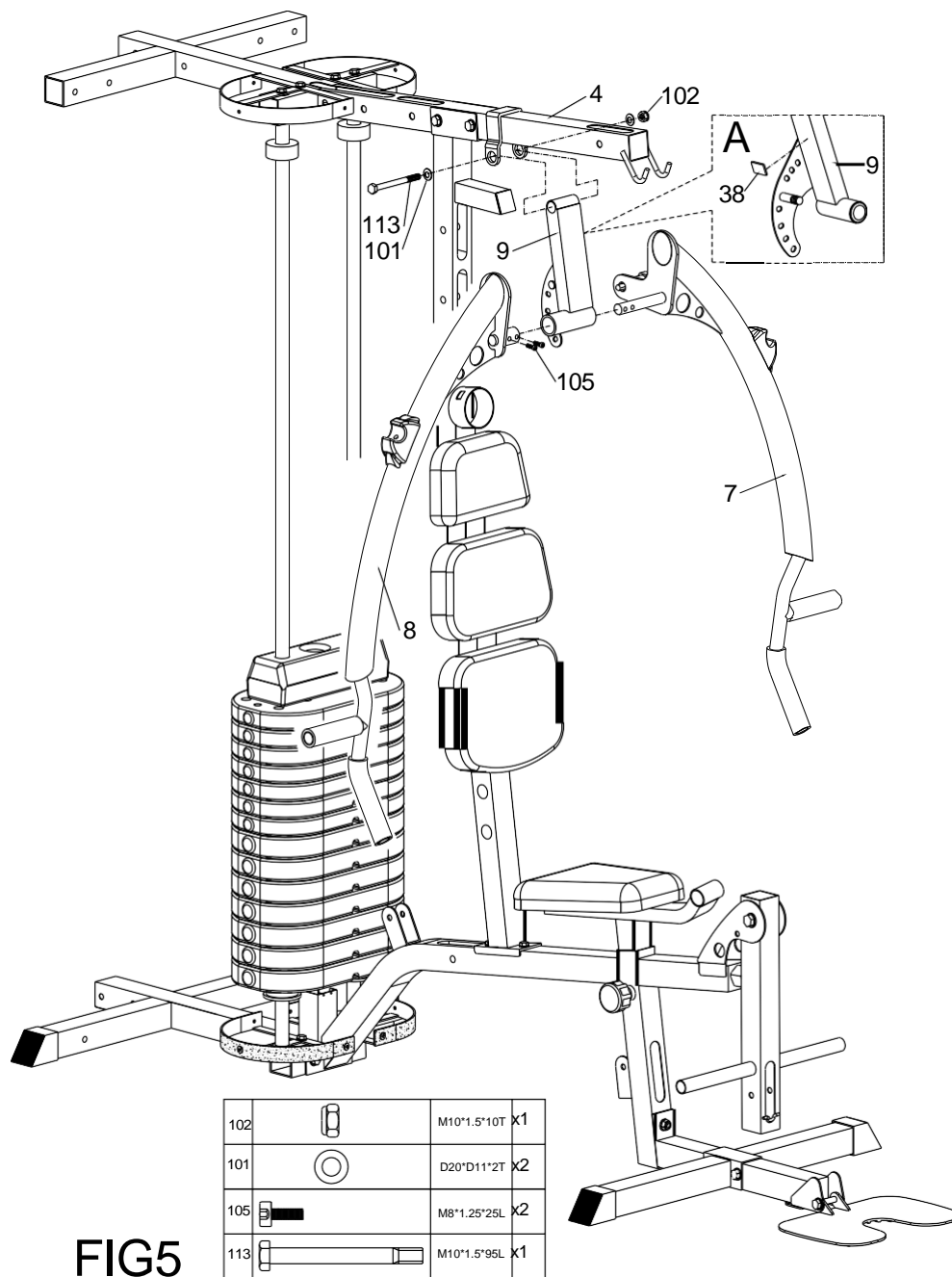
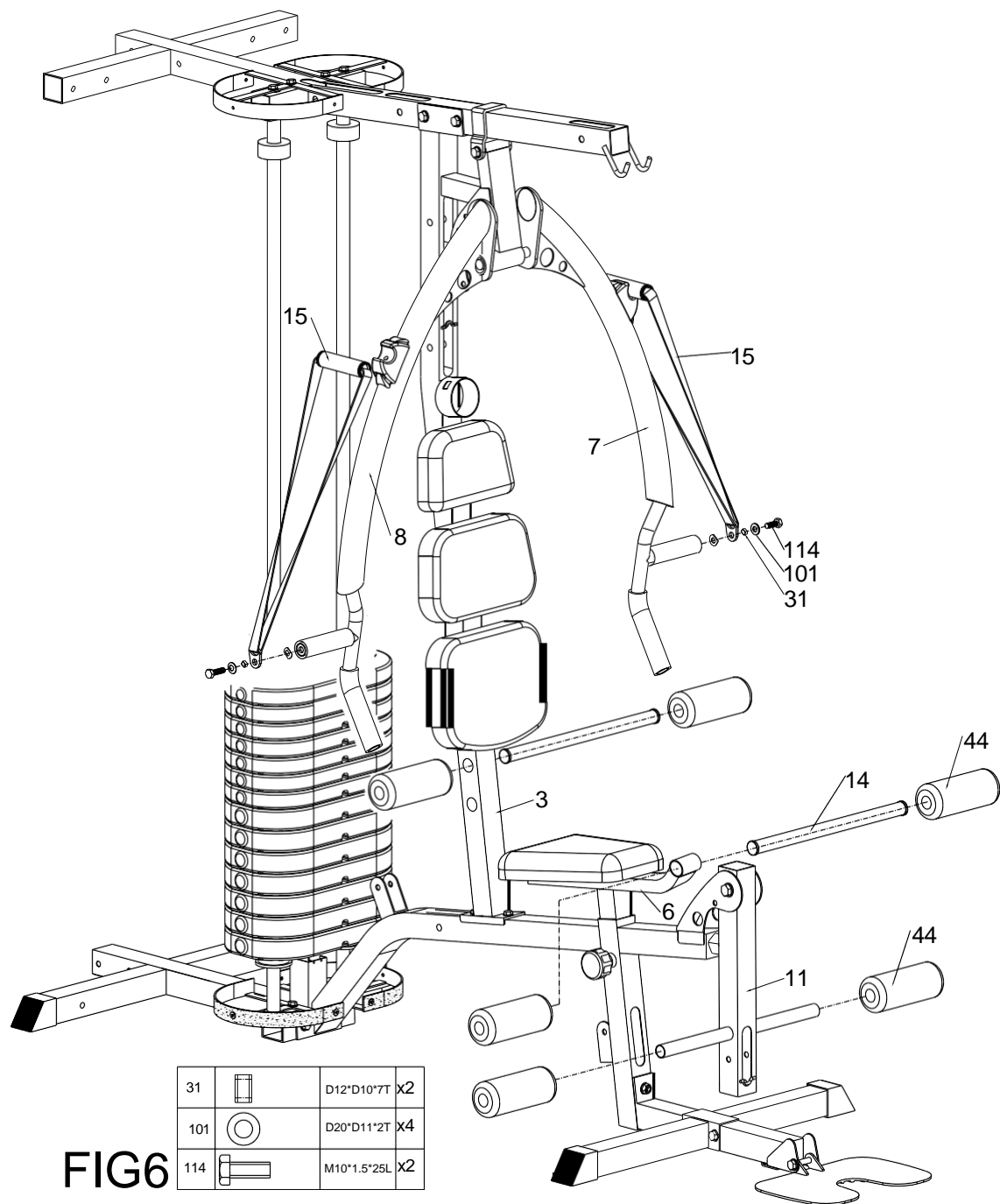

FIG5

- 1) Montati suportul pentru barele fluture (9) la cadrul superior (4) cu saiba plata (101), piulita nylon (102) si surub (113).
- 2) Montati bara stanga fluture (7) si bara dreapta fluture (8) la suportul pentru barele fluture (9) cu surub (105).
- 3) Atasati amortizorul patrat (38) pe suportul pentru fluturari (9) ca in fig A.

Pasul 6



- 1) Asamblati cureaua (material) (15) la bara stanga fluture (7) si bara dreapta fluture (8) cu saiba (31), saiba plata (101) si surub (114).
- 2) Montati axul rotator spuma (14) la suportul vertical frontal (3), suportul scaun (6) si tubul extensie picioare (11). Asamblati spuma (44) la axul rotator spuma (14).

Pasul 7

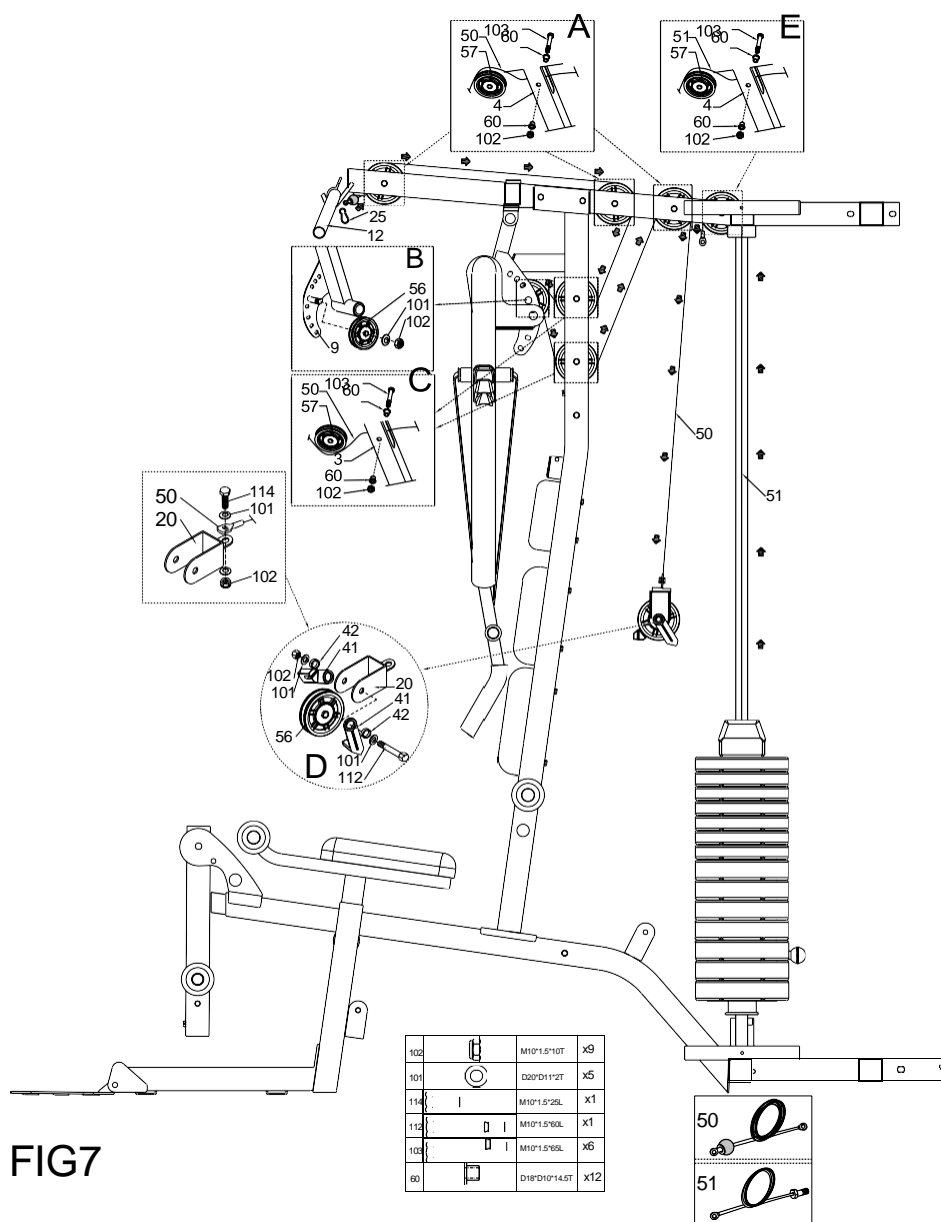
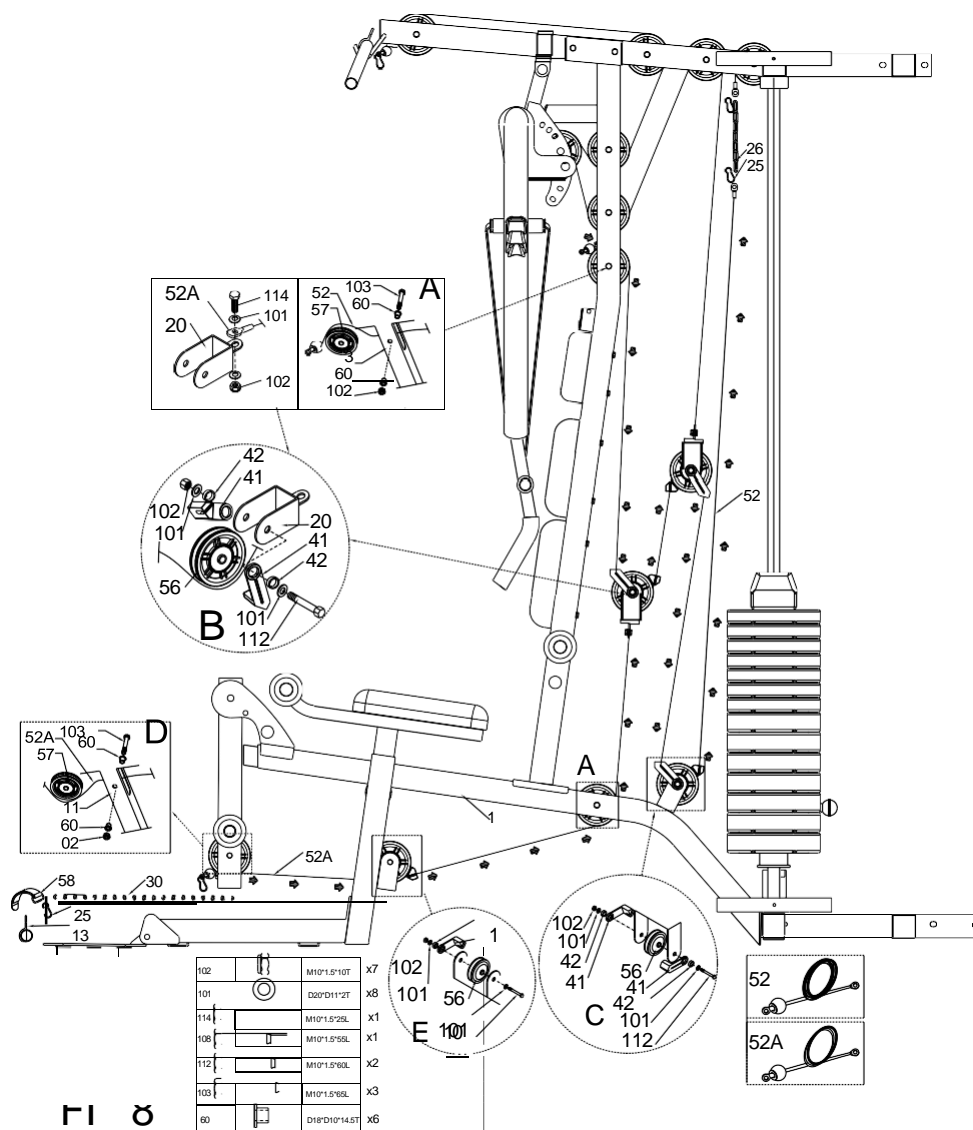

FIG7

- 1) Utilizati saiba plata (57) la cadrul superior (4) cu amortizare (60), surub (103) si piulita nylon (102) ca in fig.A.
- 2) Utilizati saiba inaltatoare (56) la suportul de maini fluturo (9) cu saiba plata (101) si piulita nylon (102) ca in fig. B.
- 3) Utilizati saiba plata (57) la suportul vertical frontal (3) cu saiba (60), boltul (103) si piulita nylon (102) ca in fig. C.
- 4) Utilizati saiba plata (56) la suportul singular saiba (20) cu bara ghidare tragere (41), inelul de plastic al scripetelui (42), saiba plata (101) si piulita nylon (102) ca in fig. D.
- 5) Introduceti cablul (50) dupa cum arata sagetile. Uniti capatul cu bucla cablului (50) la suportul singular saiba (20) langa saiba plata (101), piulita nylon (102) si surub (114).
- 6) Montati bara superioara pentru exercitiu (12) la cadrul superior (4) si la carlig (25).
- 7) Montati scripetele plat (57) la cadrul superior (4) cu saiba (60), surub (103) si piulita nylon (102) ca in fig. E. Montati cablul (51) dupa cum indica sagetile.

Pasul 8



FI 8

- 1) Montati scripetele plat (57) la suportul frontal vertical (3) cu saiba (60), boltul (103) si piulita nylon (102) ca in fig. A.
- 2) Montati scripetele inaltat (56) la suportul singular scripete (20) cu ghidarea pentru scripete (41), inelul de plastic al scripetelui (42), saiba plata (101), surubul (112) si piulita nylon (102) ca in fig. B.
- 3) Montati scripetele inaltat (56) la cadrul principal (1) langa ghidarea scripete (41), inelul de plastic al scripetelui (42), saiba plata (101), boltul (112) si piulita nylon (102) ca in fig. C.
- 4) Montati cablul (52) dupa cum indica sagetile. Conectati cablul (52) cu cablul (51) de carlig (25) si de lant (26).
- 5) Montati scripetele plat (57) la tubul extensie picioare (11) cu ajutorul saiba (60), surub (103) si piulita nylon (102) ca in fig. D.
- 6) Montati scripetele inaltat (56) la cadrul principal (1) pe ghidarea scripete (41), inelul de plastic scripete (42), saiba plata (101), surub (108) si piulita nylon (102) ca in fig. E.
- 7) Montati cablul (52A) dupa cum indica sagetile. Montati bara de exercitii inferioara (13) sau suportul de glezna (58) la capatul cablului (52A) de lant (30) si la carlig (25).

Pasul 9

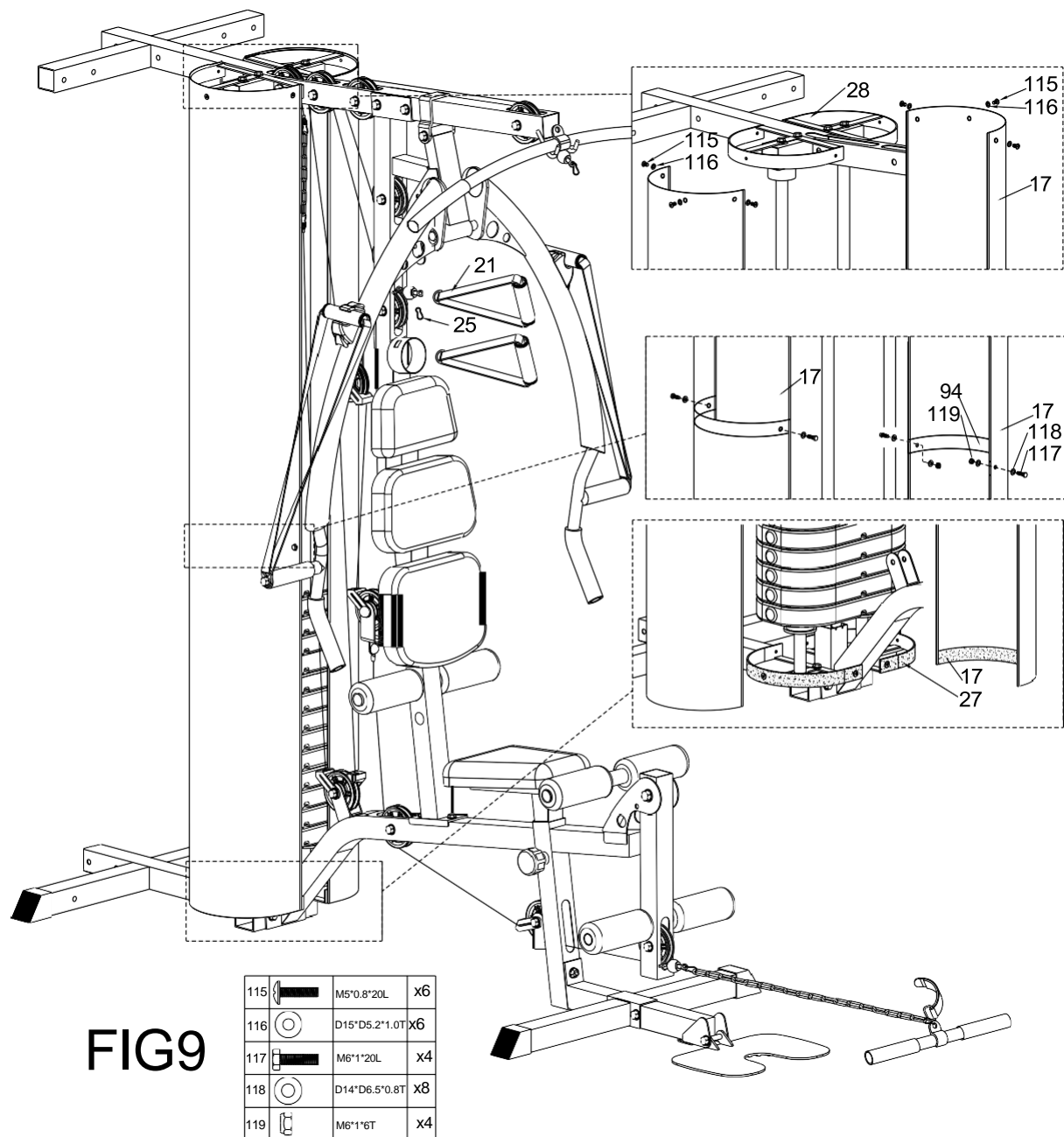

- 1) Montati placa curbata (94) la protectia greutati (17) cu surubul (117), saiba plata (118) si piulita nylon (119).
- 2) Montati aparatoarea greutati (17) la suportul inferior protectie greutati (27) si protectia superioara greutati (28) cu surubul (115) si saiba plata (116).

Pasul 10

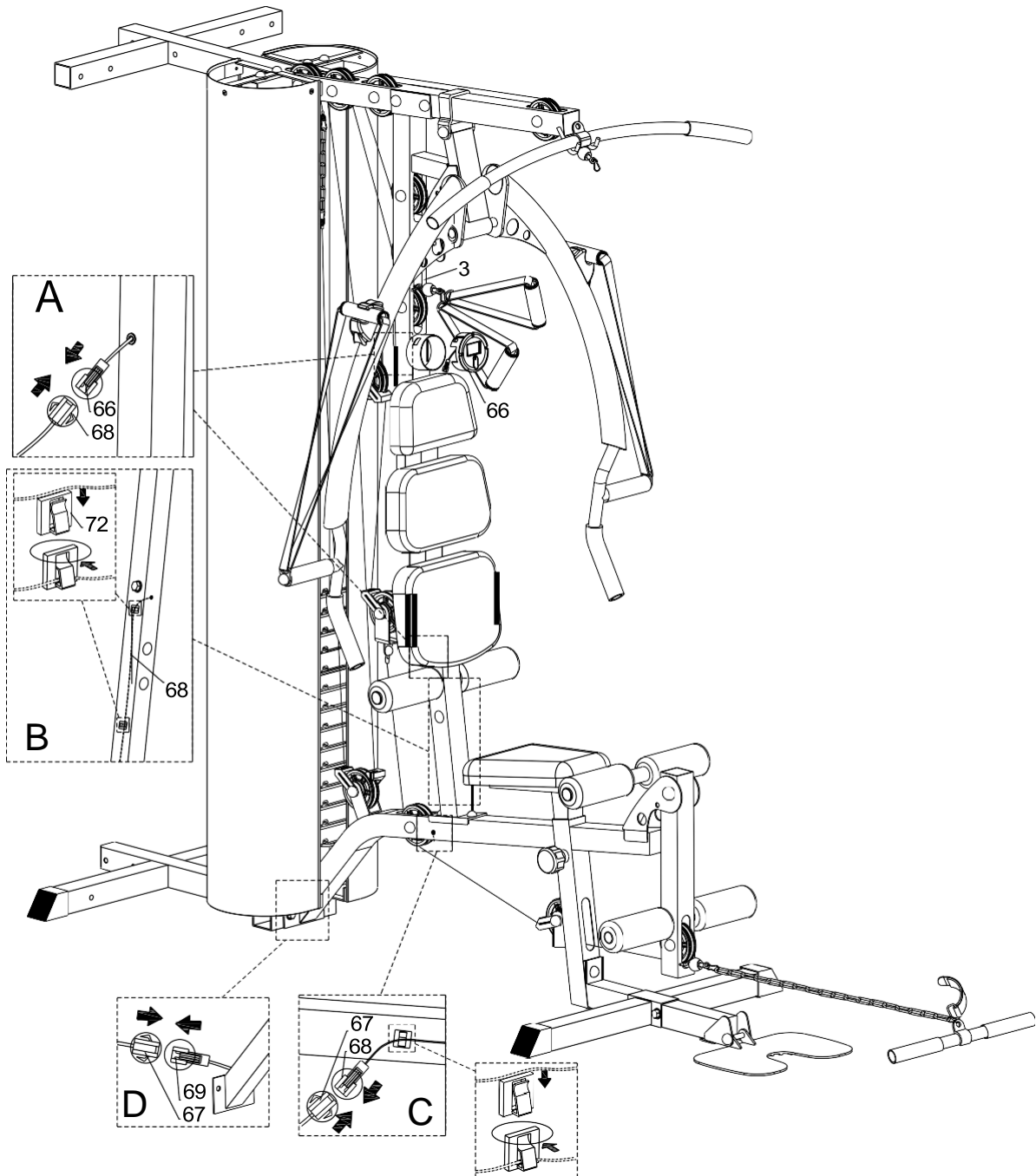

FIG10

- 1) Montati calculatorul (66) la suportul vertical frontal (3).
- 2) Conectati cablul care este pre-conectat la computer (66) cu cablul de mijloc computer (68) ca in fig. A.
- 3) Fixati cablul mijloc computer (68) in mufa pentru cablul de calculator (72) ca in fig. B.
- 4) Conectati cablul superior calculator (67) la cablul mijloc computer (68) ca in fig. C.
- 5) Conectati cablul superior computer (67) la cablul inferior computer (69) ca in fig. D.

Pasul 11

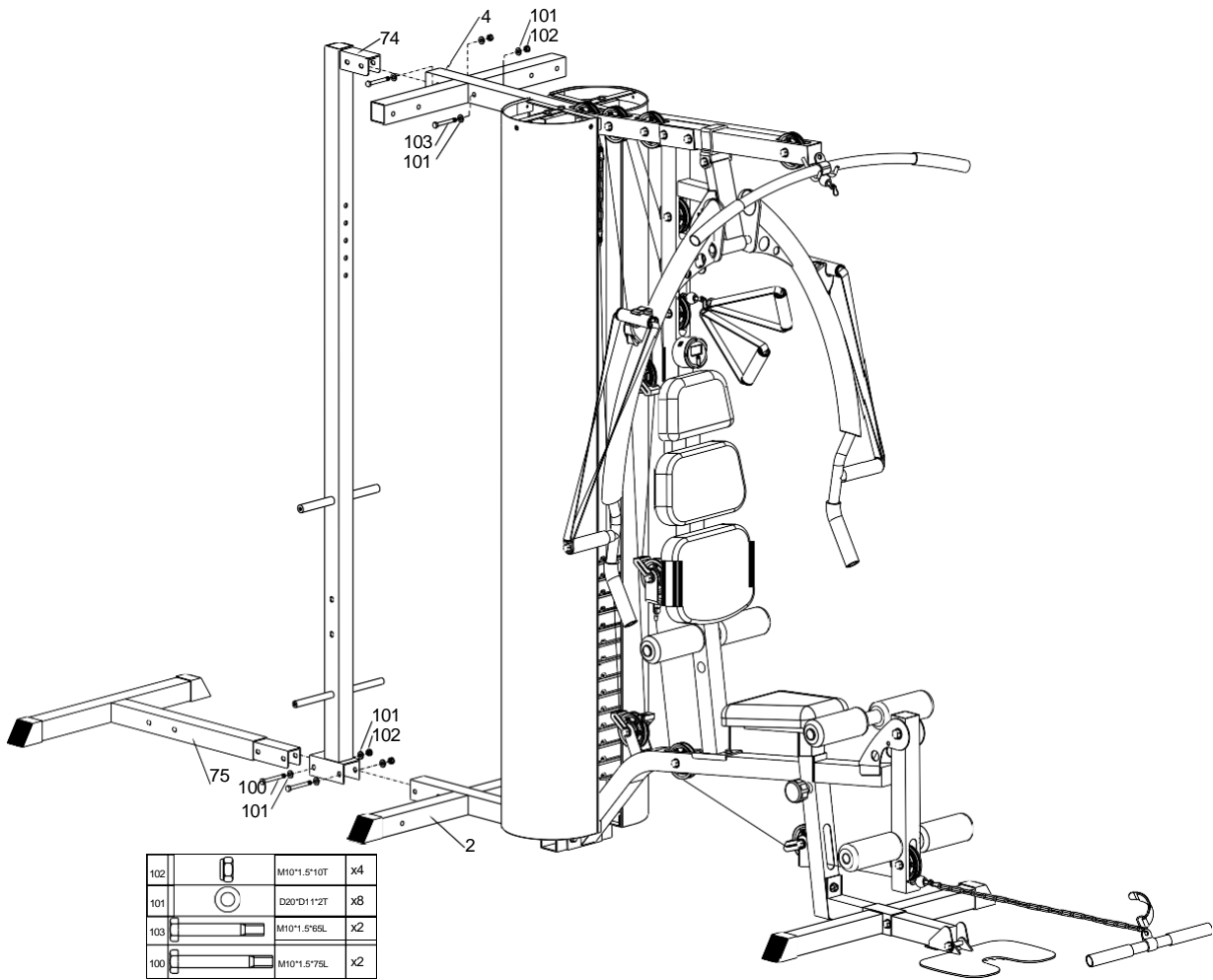

FIG11

- 1) Montati suportul vertical spate (74) pe cadrul principal (4) cu saiba plata (101), piulita nylon (102) si surub (103).
- 2) Montati cadrul podea spate (75) la cadrul de mijloc podea (2) si la suportul vertical spate (74) cu saiba plata (101), surub (100) si piulita nylon (102).

Pasul 12

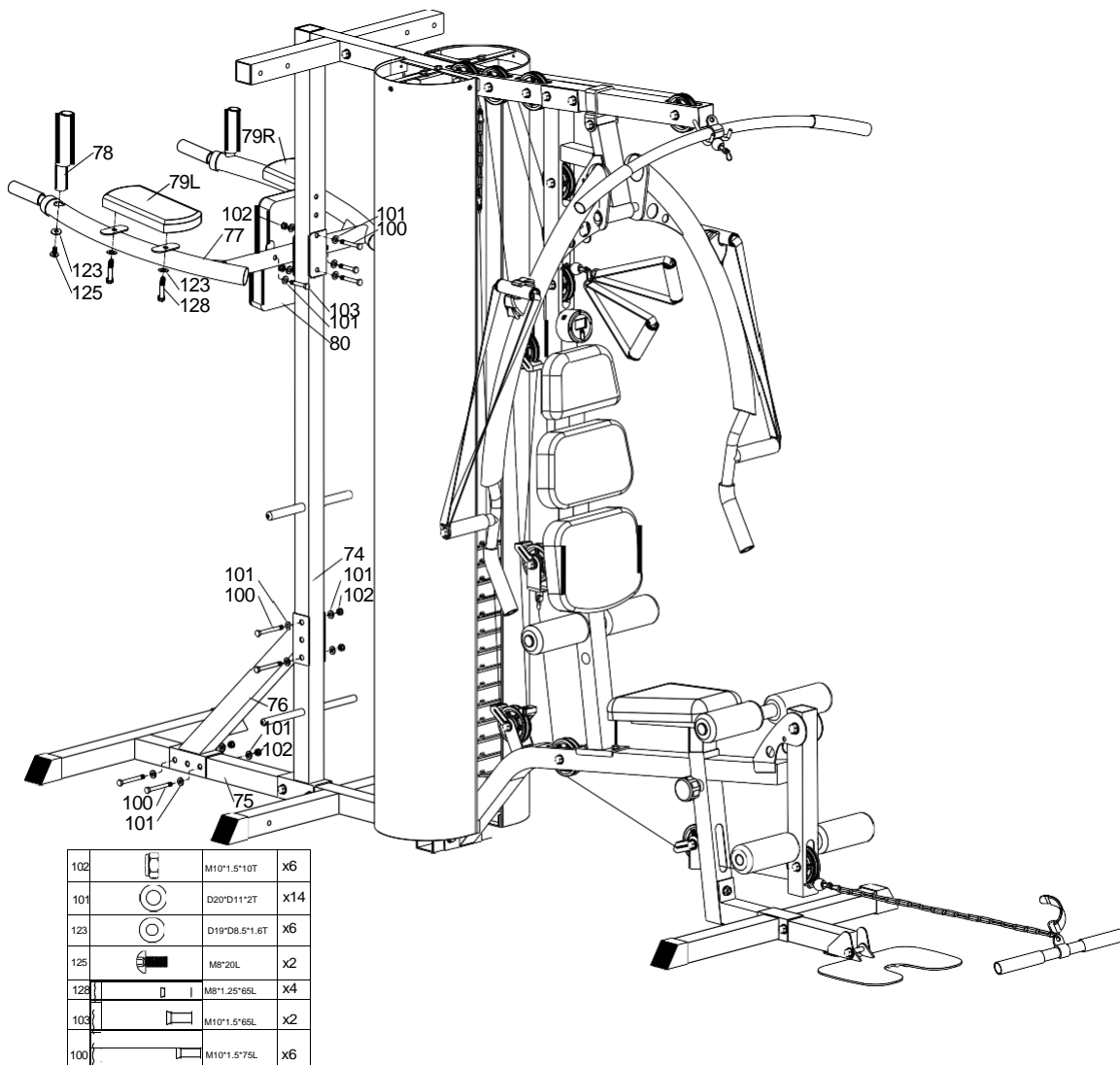

FIG12

- 1) Montati bara sustinere support maini (77) la suportul vertical spate (74) cu surubul (100), saiba plata (101) si piulita nylon (102).
- 2) Montati spatarul (80) la bara de sustinere support maini (77) cu saiba plata (101) si surubul (103).
- 3) Montati suportul stang maini (79L) si suportul drept maini (79R) pe bara de sustinere support maini (77) cu saiba plata (123) si surubul (128).
- 4) Montati manerul (78) pe bara de sustinere support maini (77) cu saiba plata (123) si surubul (125).
- 5) Montati suportul inclinat spate (76) la suportul spate vertical (74), si la suportul podea spate (75) cu surubul (100), saiba plata (101) si piulita nylon (102).

Pasul 13

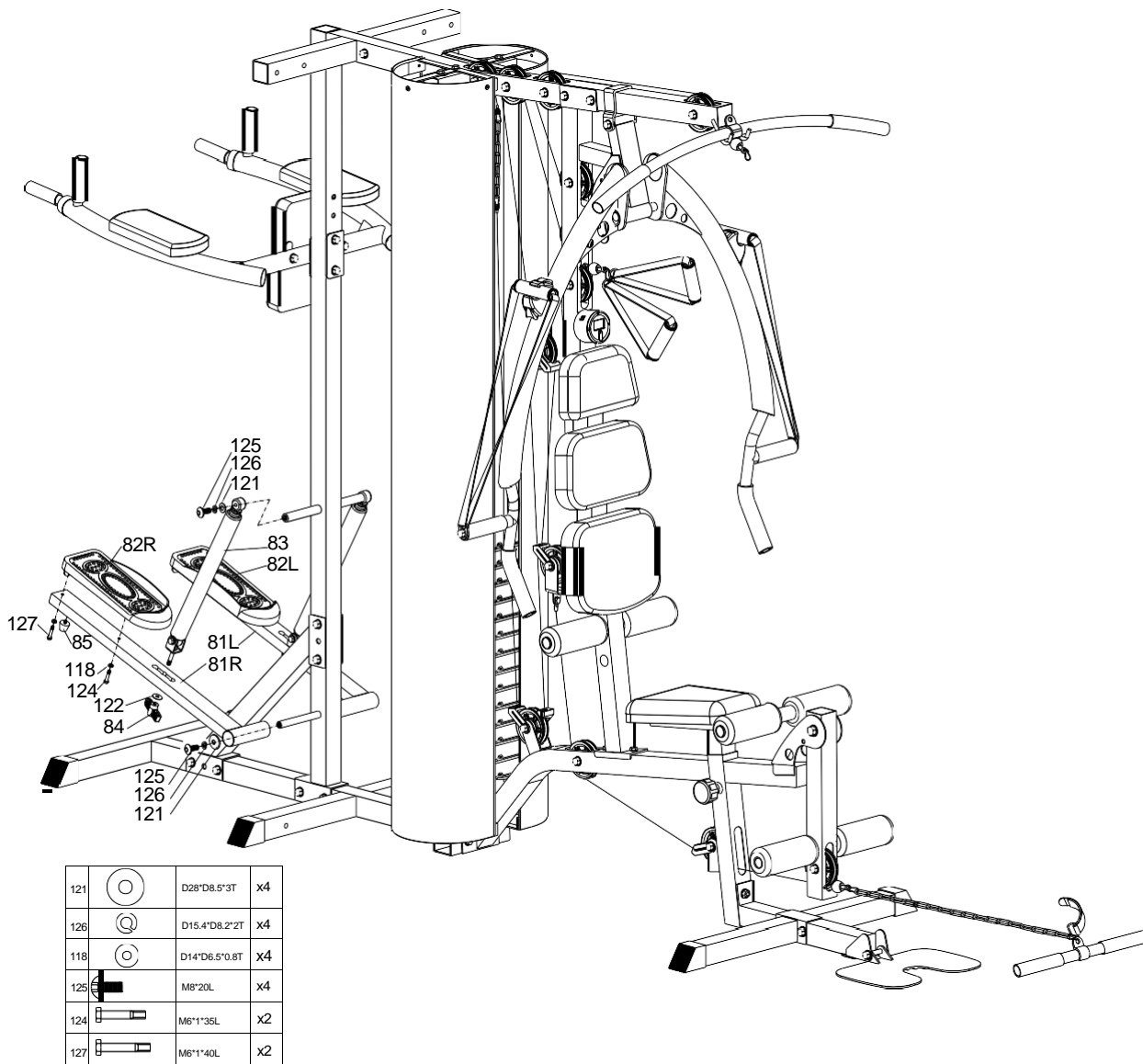

FIG13

- 1) Montati suportul pedalier stang (81L) si suportul pedalier drept (81R) la suportul vertical spate (74) cu saiba plata(121), surub (125) si saiba arcoidala (126).
- 2) Montati cilindrul hidraulic (83) la suportul vertical spate (74) cu saiba plata (121), surub (125) si saiba arcoidala (126). Montati cilindrul hidraulic (83) la suportul pedalier stang (81L) si la suportul pedalier drept (81R) cu surubul T(84) si saiba plata (122).
- 3) Montati pedala stanga (82L) si pedala dreapta (82R) la suportul pedalier (81L&81R) cu saiba plata (118), surubul (124) si boltul(127).
- 4) Montati amortizorul (85) la suportul pedalier (81L&81R).

Pasul 14

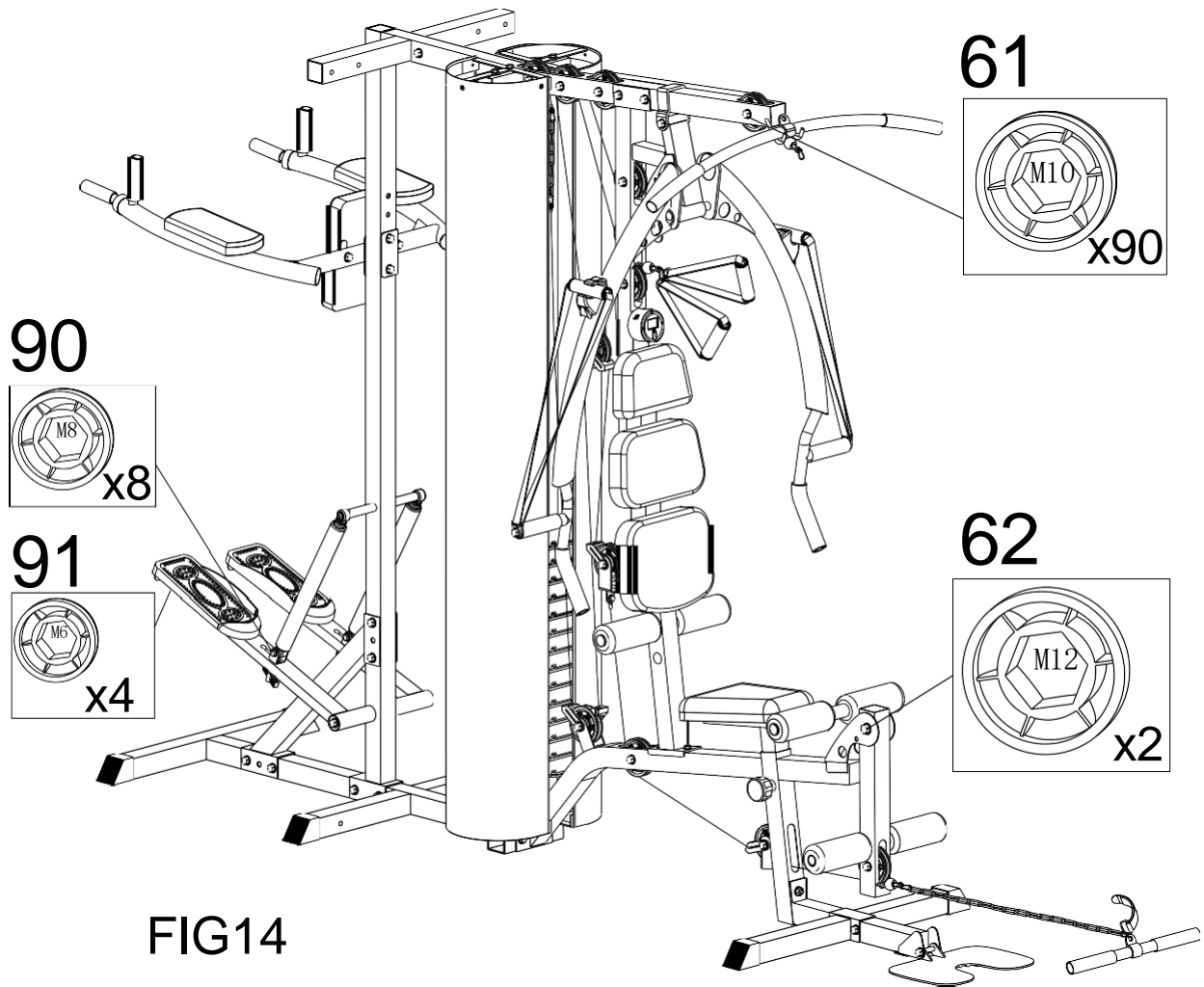
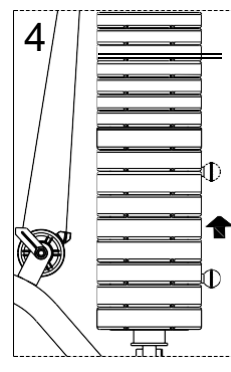
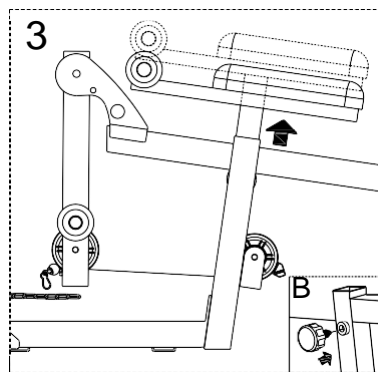
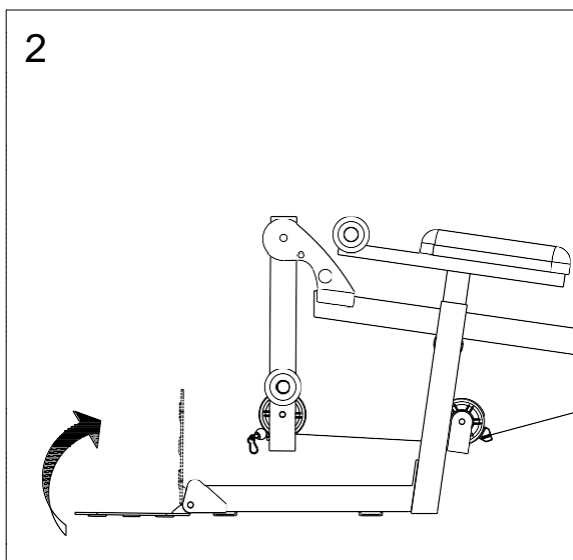
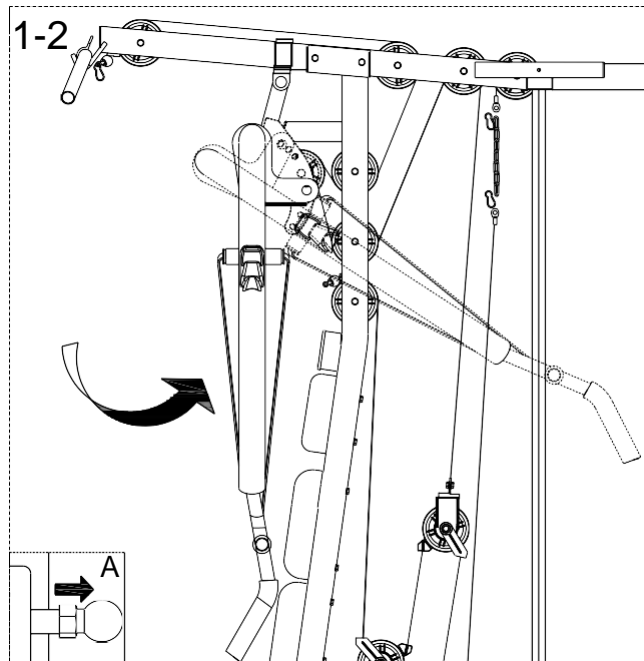
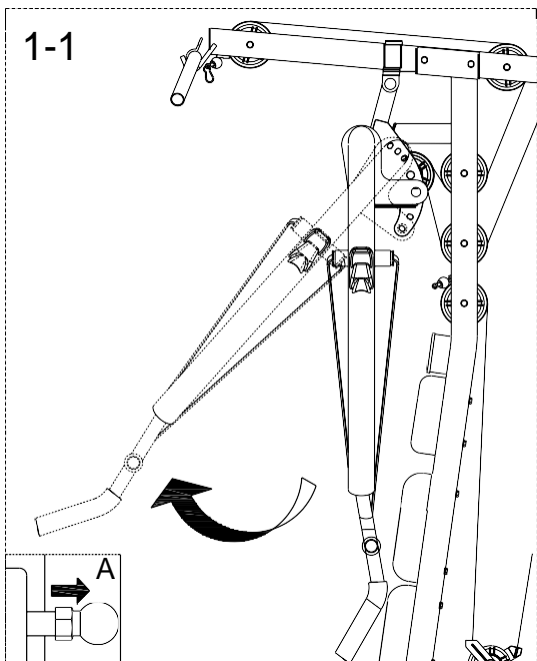

FIG14

Puneti capacele (61&62&90&91) pe suruburi.

Note



- 1) Utilizatorii pot trage barile pentru fluturari atat in fata cat si in spate in functie de tipul de exercitiu dorit ca in fig. 1-1 si fig 1-2.
- 2) Suportul de picioare poate fi reglat vertical ca in fig. 2.
- 3) Inaltimea scaunului poate fi reglata ca in fig. B.
- 4) Utilizatorii pot regla cantitatea de greutate cu ajutorul cuiului de fixare.

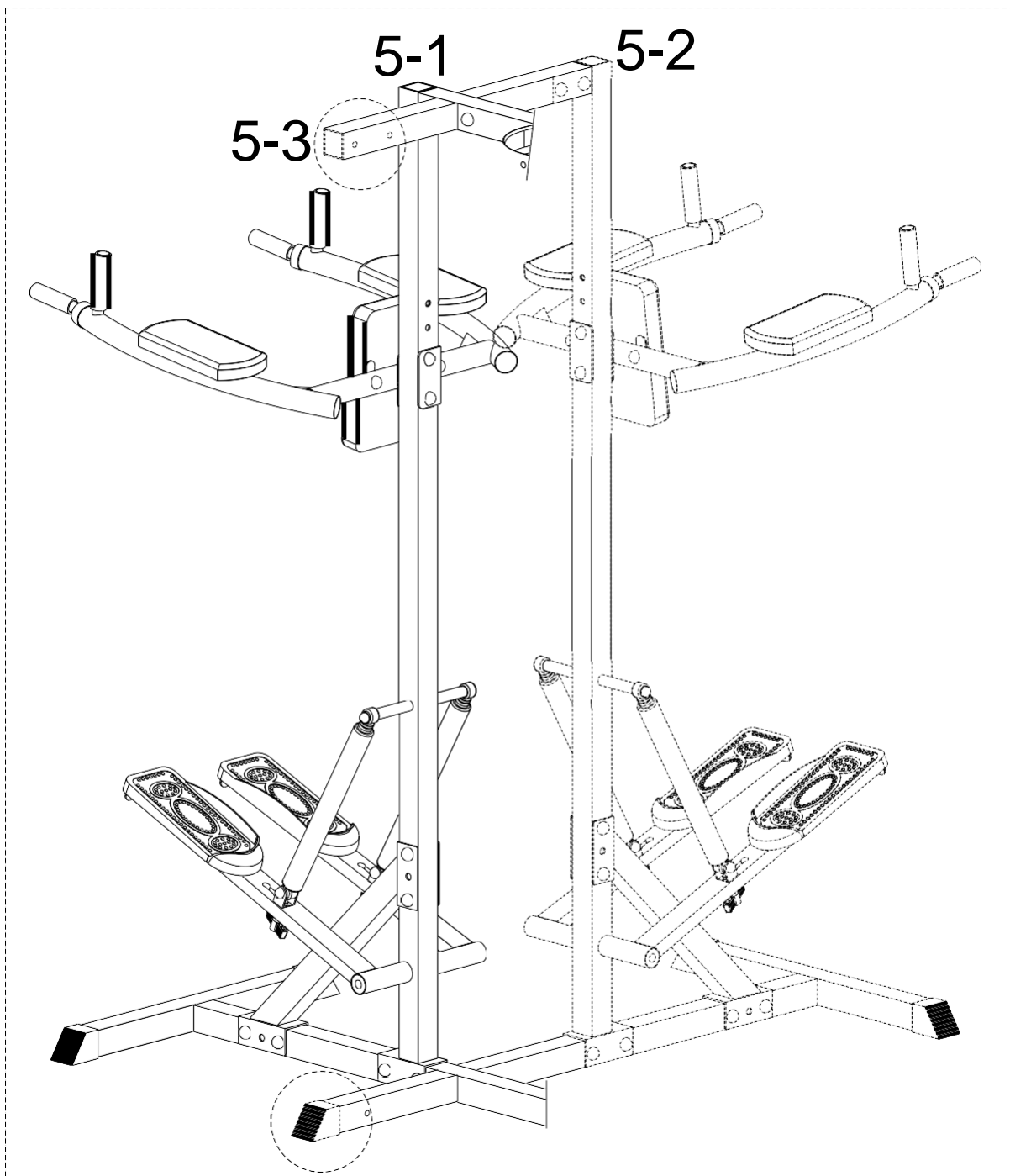

VKR+STEPPER-ul pot fi reglate in pozitii diferite ca in fig. 5-1/2/3.

1. Partea din spate a obiectului;
2. Partea stanga;
3. Partea dreapta.

Instructiuni de utilizare computer(BC-80258)

Montarea bateriei

1. Scoateti computerul din ambalaj si introduceti bateria <1.5V cell>in conformitate cu ilustratia de pe spatele computerului.
2. Conectati cumputerul la cablu ca in urmatorul desen si introduceti-l in locul special de pe capac
3. Asigurati-va ca nu ati prins cablul

Specificatii

TIMP ----- 00:00—99.59
REPETARI/MIN ----- 15—3000RPM
NUMARATOARE-----0 -- 9999
CALORII----- 0---9999

SCANARE

Functii ale tastelor

MODE/SELECT

1. Pentru a selecta functia pe care o doriti. Tineti apasat timp de 2 secunde pentru a resta complet aparatul
2. Pentru a introduce date si pentru a reseta.

AUTO ON/OFF:

Monitorul se stinge automat daca nu primeste nici un semnal timp de 256 de secunde. Monitorul va porni automat odata cu inceperea antrenamentului sau in urma apasarii oricarei taste.

Functii

- <1>TIMP ----- Automemorarea timpului de antrenament in timpul acestuia.
<2>REPETARI/MIN ----- Afiseaza pasii pe minut in timpul antrenamentului.
<3>NUMARATOARE --- Acumuleaza pasii in timpul antrenamentului.
<4>CALORII --- Automemoreaza cantitatea de calorii consumata in timpul antrenamentului.
<5>SCANARE ----- Scanare automata a fiecarei functii.

1.TIMP 2.NUMARATOARE 3.CALORII 4.NUMARATOARE TOTALA 5.SCANARE

Operarea

1. Cand bateria a fost inserata, ecranul va arata toate graficele timp de o secunda, urmand un beep de o secunda. Calculatorul va intra in functia de testare, aratand dimensiunea rotii (timp de o secunda), dupa care va afisa valoarea calorica (timp de o secunda), dupa care se va intoarce la functia de timp.

2. Cand bateria a fost inserata, ecranul va arata toate graficele pentru o secunda, dupa care consola va intra automat in functia de timp.

3. Daca nu este folosit timp de 256 de secunde, consola se va stinge automat. Orice semnal detectat va reporni consola.

4. Apasarea tastei MODE in timpul antrenamentului va permite selectia functiei dorite.

3.1 Functia de numarare are urmatoarea ordine de afisare: (1 FEREAȘTRA)

TIMP → NUMARĂTOARE → CALORII → TOTAL → CUMULAT

SCANARE

3.2 Functia de numerare are urmatoarea ordine de afisare: RPM va fi afisat constant, nu este inclusa in modul desetare.

TIMP → NUMARĂTOARE → CALORII → TOTAL CUMULAT

SCANARE

3.3 Cand tineti apasat timp de 2 secunde, va reseta toate valorile (mai putin TOTAL CUMULAT), si se intoarce la setarile din fabrica.

3.4 Daca tineti apasat timp de 5 secunde, intra in modul de setare. Modul de setare va fi afisat dupa cum urmeaza: Timp -> Numaratoare -> Calorii -> Iesire (din modul setari)

TIMP → NUMARĂTOARE → CALORII



CERTIFICAT DE GARANTIE

Nume marca produs :

Model :

Vanzator :

Cu factura/chitanta

Reparatiile se vor efectua la magazinul:

Adresa:

Semnatura si stampila :

Cumparator :

Data cumpararii:

Semnatura/stampila:

S-au efectuat probe de functionare, mi s-au inmanat instructiunile de folosire si mi s-a aratat modul de intrebuintare.

Prin prezenta, sunt de accord cu conditiile de garantie.

Prin prezenta confirm ca am primit produsul in perfecta stare de functionare impreuna cu ghidul de utilizare in limba romana si am luat la cunostiinta ca prezentul certificat de garantie este valabil numai insotit de chitanta sau factura de achizitie. Daca produsul nu este insotit de prezentul certificat sau garantia este expirata sau anulata de catre service datorita utilizarii in conditii anormale conform paragrafului 5, reparatia se va efectua cu acordul meu contra cost.

Punerea in functiune : Se vor respecta cu stictete instructiunile de montaj si punere in functiune care insotesc aparatele. La prima utilizare a aparatului, exercitiile se vor face usor pentru a constata daca functioneaza perfect.

Conditii de acordare a garantiei

1. Termenul de garantie este de 24 luni de la data cumpararii produsului si respectiv ale accesoriilor standard aflate in componenta sa (cumparate simultan cu produsul, cele fara de care aparatul nu poate functiona). Asigurarea garantiei consat in repararea aparatului in stare de functionare.

2. Garantia se acorda conform legislatiei romane in vigoare la data cumpararii, se aplica numai daca aparatul este folosit corespunzator (in concordanta cu instructiunile de folosire) si este valabila numai insotita de chitanta sau factura de cumparare si certificatul de garantie, ambele in original. Durata timpului de garantie se prelungeste cu timpul scurs de la data depunerii reclamatiei pana la recuperarea

3. In cazul defectarii in conditii normale de utilizare, pe durata perioadei de garantie, produsul se va repara gratuit, la sediile mentionate in acest certificat. Durata medie de utilizare a produsului este de 5 ani.

4. Situatii care duc la iesirea din garantie a produsului:

- Nerespectarea conditiilor de manipulare, transport, pastrare, instalare, punere in functiune, exploatare si intretinere prevazute in manualul de utilizare sau in conditii ce contravin standardelor tehnice din Romania;
- Documentele de garantie nu sunt prezentate, au fost deteriorate / modificate sau sunt ilizibile;
- Aparatul prezinta deteriorari cauzate de accidente mecanice, lovituri, socuri, patrunderi de lichide, expuneri la foc, utilizare gresita sau neglijenta, schimbari ale starii aparatului, pastrarea in conditii improprii – functionarea repetata in regim de mari diferente de temperatura care cauzeaza fenomenul de “condens” intern, expunerea excesiva la umezeala sau radiatii solare, deteriorarea capacelor de protectie sau neglijentei inutile;
- Sigiliul aplicat de catre vanzator a fost deteriorat, sters sau inlocuit;
- depozitare incorecta, lovire, suprasarcina
- cesul electronic, mansoanele de burete, bateriile, capacele, ornamentele de plastic, brate de la bicicletele eliptice, curelele de franare de la bicicletele medicinale, cablurile de la aparatele multifunctionale, nu fac obiectul garantiei
- Interventii software sau reparatii executate de catre persoane neautorizate sau alte unitati decat cele specificate in prezentul certificat;

5. Pierderea certificatului de garantie determina iesirea din garantie a produsului.

6. Perioada de garantie se prelungeste cu timpul scurs de la data predarii produsului la service, pana la data repunerii in stare de functionare a produsului. Prolungirea termenului de garantie se inscrie pe certificatul de garantie.

7. Asiguram contra cost, reparatii in afara perioadei de garantie, sau daca produsul a iesit din garantie, pe toata durata medie de utilizare a produsului.

8. Repararea produsului de folosinta indelungata defectat in perioada de garantie, atunci cand nu poate fi reparat sau cand durata de nefunctionare din cauza deficientelor aparute in perioada de garantie depaseste 10% din termenul de garantie, la cererea consumatorului, vor fi inlocuite de vanzator/comparator sau acesta va restitui consumatorului contravaloarea actualizata a produsului respective.

9. Obiectul garantiei :

- Cadrul si alte elemente metalice se schimba in caz de rupere sau fisurare, daca nu prezinta urme de lovituri sau zgarieturi;
- Foia de angrenaj se schimba in cazul in care se produce ruperea de pe axul pedalier sau in cazul in care se constata ruperea dintilor.

***CERTIFICATUL DE GARANTIE NU ESTE TRANSMISIBIL**

Fisa de reparatie in garantie

Nr.	Data receptie	Descrierea defectului	Reparatie efectuata	Prelungire garantie cu	L.S.
1					
2					
3					
4					

Distribuitor :

Sport Brands Distribution

**Str. Depozitelor nr.21, Deva,
Hunedoara**

CUI : RO33918111 ; J20/21/2010

Tel: [0377 101 449](tel:0377101449)/ office@insportline.ro

Web: www.insportline.ro

www.sport-mag.ro