

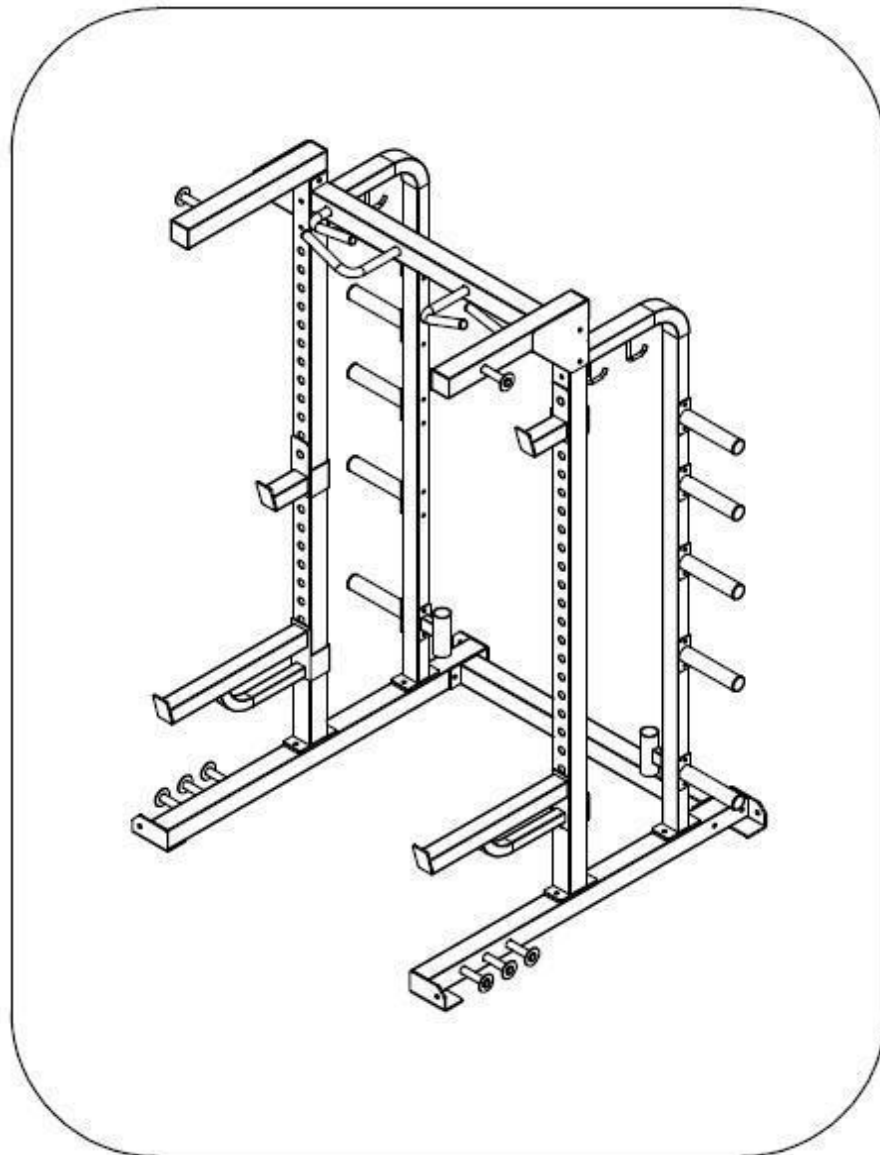

Manual de utilizare – RO

**IN 18854 Stand multifunctional inSPORTline Power rack
PW200**



CUPRINS

INSTRUCTIUNI DE SIGURANTA IMPORTANTE.....	3
INSTRUCTIUNI DE SIGURANTA	3
LISTA PIESE.....	4
ASAMBLARE.....	5

INSTRUCTIUNI DE SIGURANTA IMPORTANTE

Inainte de asamblare, scoateti continutul pachetului si verificati daca aveti toate piesele necesare asamblarii.

NOTA: Saibele si suruburile nu trebuie stranse ferm inainte de finalizarea asamblarii.

ATENTIE

Cititi cu atentie intregul manual de utilizare inainte de folosi produsul pentru prima data.

NOTA













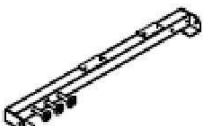



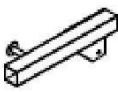

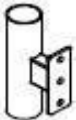
Consultati un medic inainte de a incepe orice program de exercitii, in special daca aveti peste 35 ani sau aveti probleme de sanatate. Utilizatorul se antreneaza pe propria raspundere, nu suntem responsabili de eventualele accidentari. Este responsabilitatea proprietarului sa ii instiinteze pe toti utilizatorii acestui produs cu privire la instructiunile de utilizare din acest manual.

INSTRUCTIUNI DE SIGURANTA

- Produsul nu este conceput pentru utilizare in exterior. Acesta trebuie asezat pe o suprafata plana. Pentru a evita deteriorarea podelei, va recomandam sa asezati un covor de protectie sub aparat.
- Cand va antrenati, purtati imbracaminte si incaltaminte sport. Nu va antrenati in soseste sau descul.
- Verificati daca produsul este complet functional inainte de fiecare utilizare.

Nu lasati copiii nesupravegheati in apropierea produsului.

LISTA PIESE

<p>1</p>  <p>1 bucata</p>	<p>2</p>  <p>1 bucata</p>	<p>3</p>  <p>1 bucata</p>	<p>4</p>  <p>1 bucata</p>
<p>5</p>  <p>2 bucati</p>	<p>6</p>  <p>2 bucati</p>	<p>7</p>  <p>1 bucata</p>	<p>8</p>  <p>1 bucata</p>
<p>9</p>  <p>2 bucati</p>	<p>10</p>  <p>1 bucata</p>	<p>11</p>  <p>1 bucata</p>	<p>12</p>  <p>1 bucata</p>
<p>13</p>  <p>1 bucata</p>	<p>14</p>  <p>10 bucati</p>	<p>15</p>  <p>Surub M12*95, saibe, piulite 8 bucati</p>	<p>16</p>  <p>Surub M12*100, saibe, piulite 4 bucati</p>
<p>17</p>  <p>Surub M10*90, saibe, piulite 16 bucati</p>	<p>18</p>  <p>Surub M10*95, saibe, piulite 4 bucati</p>	<p>19</p>  <p>Surub M12*20, saiba 8 bucati</p>	

ASAMBLARE

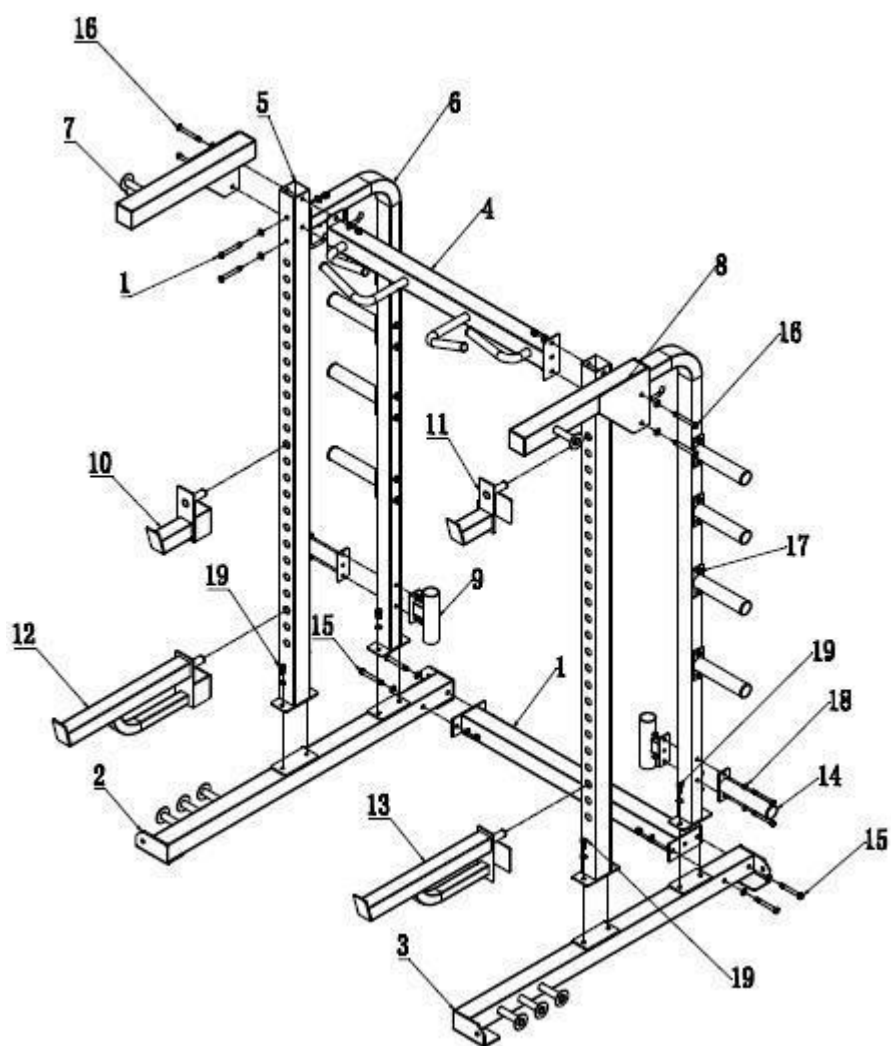

Piulitele sunt prevazute cu inel de blocare din silicon, strangeti-le bine cu o cheie.



Distribuitor

Sport Brands Distribution

Str. Depozitelor nr.21, Deva,

Hunedoara

CUI : RO33918111 ;

J20/1005/19.12.2014

Tel: 0377 101 449

comenzi@insportline.ro

Web: www.insportline.ro